

XEBEC

NEW

Patent Pending

XEBEC Brush™ Wheel Type

Innovative CNC Deburring and Polishing Solutions



Approaching burrs on a side surface and expands the solutions for CNC deburring and polishing!

Features

- Removing burrs on a side surface
- Innovative brush made of XEBEC's original ceramic fibers
- CNC deburring and polishing by “overwhelming grinding power”, “consistent cutting performance” and “no deformation”

※Our products do not contain refractory ceramic fibers.

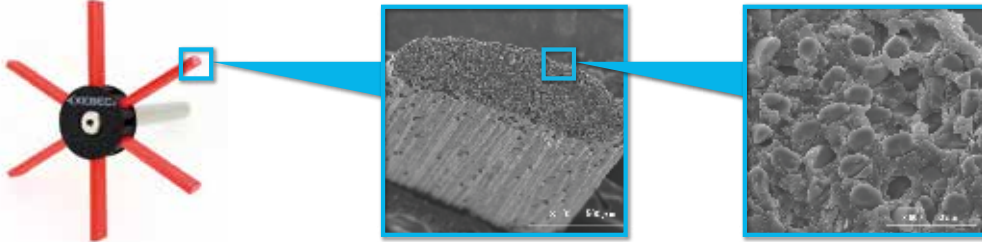

Product Structure

The main unit (brush) and a shank are sold separately.
Insert a shank into a brush unit before use. When replacing a brush, order only a brush part.



Example

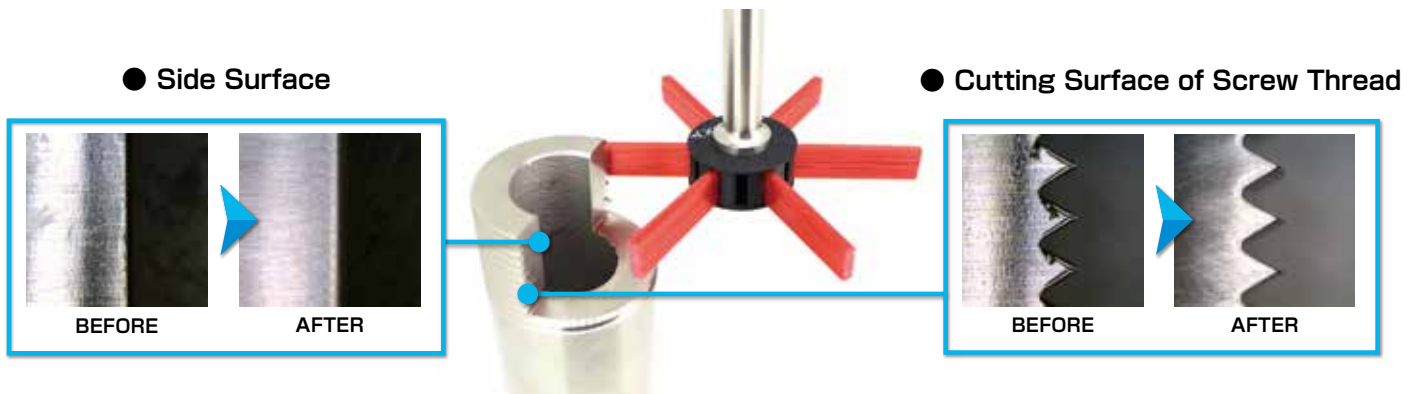

Applicable Workpiece

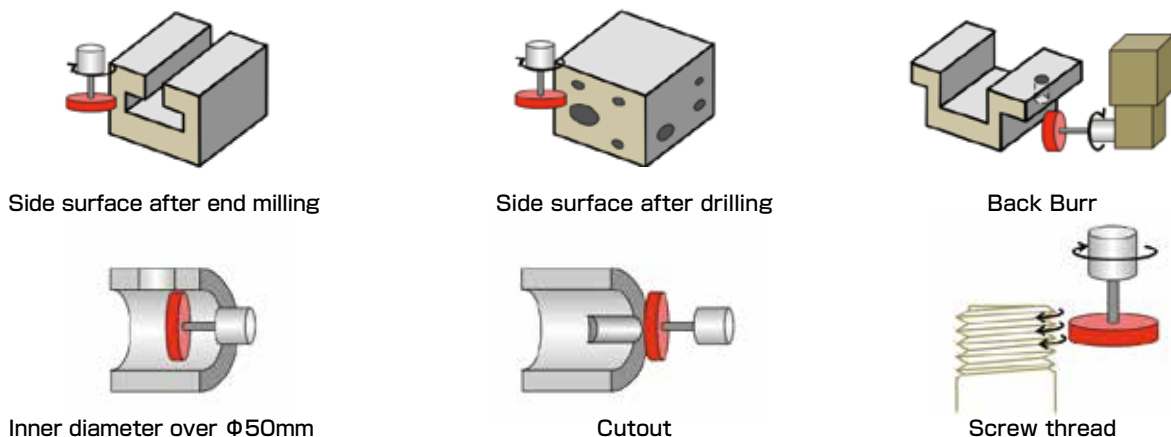

Demo movie available on our website

Lineup and Product Specification

■ Main Unit (Brush)

Product Code	Brush Diameter (mm)	Number of Bundles	Bristle (color)	Dimension
W-A11-50	φ50	6	A11 (Red)	Figure1
W-A11-75	φ75	6		

■ Shank (Attachment : Dedicated screw (Product Code : W-SC-M4-6) × 1 piece)

Product Code	Shank Length (mm)	Shank Diameter (mm)	Set Screw	Dimension
W-SH-M	70	φ8	M4	Figure2
W-SH-L	150	φ12		Figure3

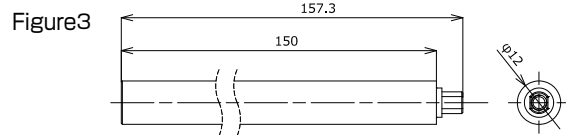
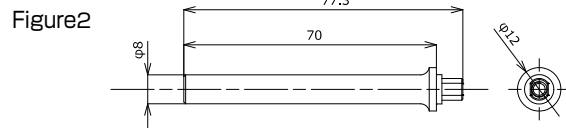
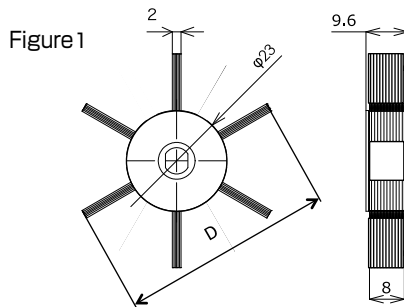

Processing Conditions

■ Initial Processing Conditions

Product Code	Cutting Speed (m/min)	Spindle Speed (min ⁻¹)	Feed per Bundle (mm/bundle)	Table Feed (mm/min)	Depth of Cut (mm)
W-A11-50	250	1600	0.5	4800	0.2
W-A11-75	250	1000	0.5	3000	0.2

■ Processing Conditions Range

Product Code	Cutting Speed (m/min)	Feed per Bundle (mm/bundle)	Depth of Cut (mm)	Max. Spindle Speed (min ⁻¹)
W-A11-50/W-A11-75	150~350	1.5 and under	0.5 and under*	3000

*As bristles are worn out, bristle length becomes shorter and increases stiffness, causing bristles to be broken. If bristles breakage occurs, please decrease the depth of cut.

- The processing conditions may differ depending on burrs. Make adjustments according to the quality of the workpiece.
- If burrs remain, increase the number of passes.
- To extend tool life, increase the feed per bundle.

The optimal approach is to place a brush at the center angle to the edge. (Figure 4)
Rotate clockwise direction first and then counter-clockwise direction.

Alternatively, burrs can be removed by placing a brush as shown on Figure 5.
Rotate clockwise direction first and then counter-clockwise direction.

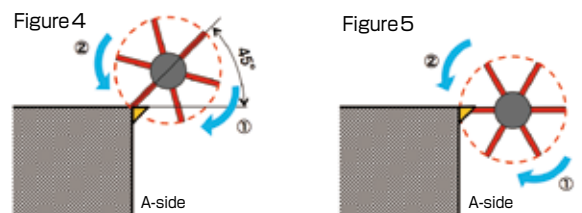

Tool Wear Offset

The depth of cut of this brush is extremely small. The brush wear needs to be corrected in a radial direction as it is worn out. The brush diameter needs to be corrected either manually or automatically by using a program. Please see our web site for the details.

Reference Tool Life

[TOOL] W-A11-50 (+W-SH-M)

[MATERIAL] Iron(S45C), Burr root thickness 0.1mm, Cutting process: End milling

[PROCESSING CONDITION]

Cutting speed : 250m/min (Spindle speed : 1600min⁻¹)

Feed per bundle : 0.7mm/bundle (Table feed : 7000mm/min), Depth of Cut : 0.2mm

Placing a wheel type brush to a 120mm-length edge

[RESULT] 600m $600m(=600,000mm) \div 120mm=5,000pcs$

*Tool life differs depending on processing conditions and material.

Machining Equipment

The tool can be mounted on apparatuses that control the spindle speed and depth of cut.

● Machining centers

Can be used with a milling chuck holder or collet chuck holder.



● Combined lathe

Can be used with a milling holder for X-axis or Y-axis.



Attention

- Please make sure to read the user manual before use.
- In order to ensure safety, please observe the operator safety measures and operational precautions listed below.

The precautions herein described are made available for the products to be used safely and to prevent injuries and/or damages from occurring to others.

[Operator safety measures]

[Wear Protective Equipment] Always wear safety glasses, protective gloves and masks when operating the tool. In addition, wear long sleeves and have the cuffs/bottom of the jacket properly closed to minimize skin exposure.

[Use Protective Cover] Install covers on the machine tool and special-purpose machine, and use them while they are protected safely with the covers. Implement sufficient safety measures in order to ensure one's physical safety in the unlikely event of fragments scattering.

[Beware of Grinding Powder] Grinding powder and burrs may scatter within an area around the work as the brush revolves; therefore, please collect dust using a dust collector and stay clear of this area.

[Caution to Your Surroundings] Because it could be dangerous if tool fragments and/or chip powder scatter while working, enclose the potentially dangerous work area to prevent other people from entering, or have those around the work area wear protective equipment.

If these safety measures are neglected, there are following risks.

- If the tool fragments and/or chip powder gets into the eyes, there is the risk of losing eyesight in the worst case.
- If the tool fragments and/or chip powder hit the skin, there is the risk of getting injured. · Dust generated by machining process may cause skin irritation or allergy.

Please see our web site for the details.

<https://www.xebec-tech.com>



XEBEC TECHNOLOGY CO., LTD.

1-7-25, Koujimachi, Chiyoda-ku, Tokyo 102-0083, Japan

Phone. +81-3-3239-3481 FAX. +81-3-5211-8964

URL. <http://www.xebec-tech.com> E-mail. info@xebec-tech.co.jp

Varró és Király Bt.

2721 Pilis, Zrínyi Miklós utca 20

mobil: 36 30 2334765

www.vkbt.hu , vkbt@t-online.hu